

## Control Relays – Overview



SERIES GP



SERIES TR

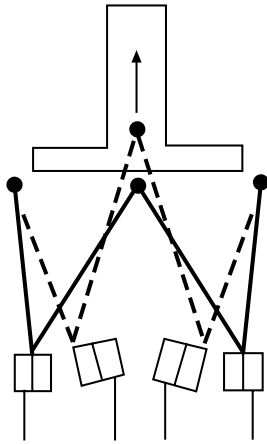

**Diagram illustrates amplification obtained by articulated operating mechanism.**

### DESIGN FEATURES

Among the advances Agastat Control Relays offer over existing designs is a unique contact operating mechanism. An articulated arm assembly amplifies the movement of the solenoid core, allowing the use of a short stroke

coil to produce an extremely wide contact gap. The long support arms used in conventional relays are eliminated. Both current capacity and shock/vibration tolerance are greatly increased, as well as life expectancy.

### DESIGN/CONSTRUCTION

Agastat Control Relays are operated by a moving core electromagnet whose main gap is at the center of the coil. A shoe is fitted to the core which overlaps the yoke and further increases the magnetic attraction.

The coil itself is in the form of an elongated cylinder, which provides a low mean turn length and also assists heat dissipation. Since the maximum travel of the electromagnet does not provide optimum contacts movement, an ingenious amplifying device has been designed.

This consists of a W-shaped mechanism, shown in figure 1. When the center of the W is moved vertically the lower extremities move closer to each other as can be seen in the illustration. The center of the W mechanism is connected to the moving core of the electromagnet and the two lower points are connected to the moving contacts.

Two of these mechanisms are placed side-by-side to actuate the four contacts sets of the relay. The outer arms of the W mechanisms are leaf springs, manufactured from a flat piece of non-ferrous metal. These outer arms act as return springs for their corresponding contacts. This provides each contact with its own separate return spring, making the contacts independent.

The mechanical amplification of the motion of the electromagnet permits a greater distance

between the contacts, while the high efficiency of the electromagnet provides a nominal contact force in excess of 100 grams on the normally open contacts.

All the contacts are positioned well away from the cover and are well ventilated and separated from each other by insulating walls.

The absence of metal-to-metal friction, the symmetrical design of the contact arrangement and the lack of heavy impacts provides a mechanical life of 100,000,000 operations.

For use in AC circuits, the relay is supplied with a built-in rectification circuit, thus retaining the high DC efficiency of the electromagnet. The current peak on energizing is also eliminated and consequently the relay can operate with a resistance in series (e.g. for high voltages or for drop-out by shorting the coil). The use of the rectification circuit offers still other advantages. The same model can operate at frequencies ranging from 40 to 400 cycles. Operation of the relay is crisp; even with a low AC voltage, there is a complete absence of hum and vibration.

The plastic dust cover has two windows through which the iron yoke protrudes to facilitate cooling and also to allow direct mounting arrangement of the relay irrespective of the terminals.

**Seismic & radiation tested EPR, EML and ETR models are available. Consult factory for details and special ordering information.**

## Control Relays – Series GP Power Relays



### DESIGN FEATURES

- ◆ Occupies a very small panel space
- ◆ May be mounted singly, in continuous rows, or in groups.
- ◆ Available with a screw terminal molded socket.
- ◆ 4 SPDT contacts
- ◆ Magnetic blow-out device option increases the DC current carrying capacity approximately ten times for both N.O. & N.C. contacts.
- ◆ In both AC and DC operation, the addition of the device will normally double the contact life, due to reduced arcing.

### SPECIFICATIONS

**Operating Mode:** Power Relay

**Operating Time:** Operate time at 20°C (68°F) and rated voltage:

Between energizing and opening of normally closed contacts/less than 18 milliseconds on AC and less than 15 milliseconds on DC.

**Release Time:** Between energizing and closing of normally open contacts/less than 35 milliseconds on AC and less than 30 milliseconds on DC.

Between de-energizing and opening of normally open contacts/less than 70 milliseconds on AC and less than 8 milliseconds on DC.

Between de-energizing and closing of normally closed contacts/less than 85 milliseconds on AC and less than 25 milliseconds on DC.

**Contacts:** Silver plated.

**Life:** Load Life:

**Power Consumption:** Typical power consumption at rated voltage is: 6VA for AC coils, 6 Watts for DC coils

There is no surge current during operation.

**Insulation Resistance:** Between all non-connected terminals as well as between non-connected terminals and the relay yoke: 1000 megohms at 500 volts DC

**Dielectric:** 2000 volts RMS 60 Hz between points specified above.

**Operating Temperature Range:** 0° to 60°C (32°F to 140°F)

**Mounting Terminals:** 16 flat base pins. Screw terminal sockets are available.

**Shock:** The relay, when kept energized by means of one of its own contact sets, will withstand 40g shock load when operating on DC, and 150g shock load on AC.

**Vibration:** Single axis fragility curve data are available on request at frequencies from 5 Hz to 33 Hz.

**Wire Connection:** The 16 flat pins are arranged in four symmetrical rows of four pins; the pitch in both directions being .394". Connection may be made to the relay by soldering. Sockets are available with screw terminals.

The internal wiring of the relay is also symmetrical as shown in the adjacent figure, allowing the relay to be inserted into the socket in either of two positions. Terminals B2 and B3 are provided as extra connections for special applications.

**Approximate Net Weight:** 10.9 oz

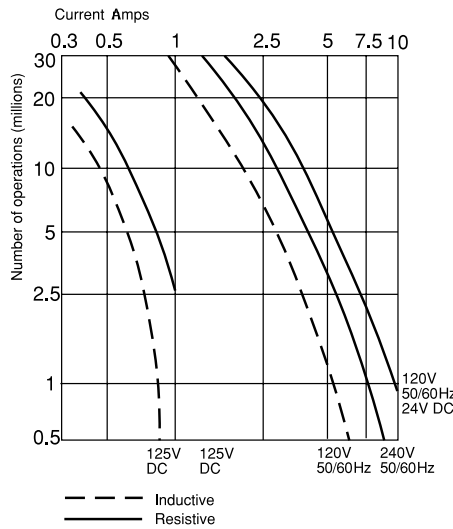
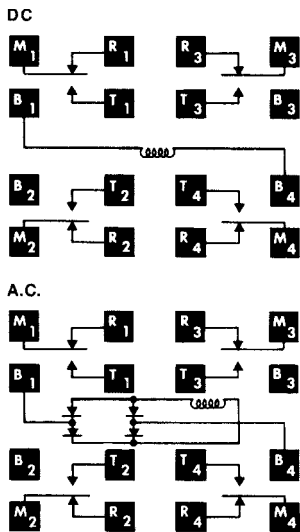
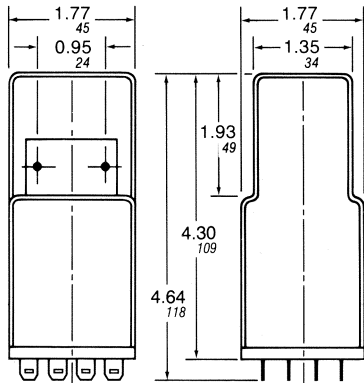

Mechanical Life: 100 million operations



File No. E15631



File No. LR29186

## Control Relays – Series GP Power Relays

### SPECIFICATIONS ( Cont.)

#### Coil Operating Voltage

|                                    | DC   |    |    |     |     | 50/60Hz |     |     |
|------------------------------------|------|----|----|-----|-----|---------|-----|-----|
|                                    | 12   | 24 | 48 | 125 | 250 | 24      | 120 | 220 |
| Nominal Coil Voltage               | 12   | 24 | 48 | 125 | 250 | 24      | 120 | 220 |
| Minimum Pick-up voltage at 40°C    | 9.5  | 19 | 38 | 100 | 200 | 20      | 102 | 188 |
| Maximum voltage for continuous use | 13.5 | 27 | 53 | 143 | 275 | 27      | 137 | 245 |

For 380 Volts AC – Use 6800 ohms 4 watt resistor in series with 220 volts AC relay

For 440 Volts AC – Use 8200 ohms 6 watt resistor in series with 220 volts AC relay

Coil drop-out voltage is between 10% and 40% of the rated operating voltages for both DC and AC (For example: in a 120 VAC unit, drop-out will occur between 12 and 48 volts.) DC relays will function with unfiltered DC from a full-wave bridge rectifier.

#### Contact Ratings

| Voltage | Current (Amps) | Power Factor or Time Constant | Number of Electrical Operations | Remarks                |
|---------|----------------|-------------------------------|---------------------------------|------------------------|
| 540 VAC | 3              | COS Ø = 0.5                   | 15 000                          | 2 contacts in series   |
| 380 VAC | 15             | Resistive                     | 10 000                          | 2 contacts in parallel |
| 380 VAC | 10             | Resistive                     | 200 000                         |                        |
| 380 VAC | 3 x 3.3        | COS Ø = 0.8                   | 200 000                         | 3hp motor              |
| 220 VAC | 20             | Resistive                     | 20 000                          | 2 contacts in parallel |
| 220 VAC | 15             | COS Ø = 0.5                   | 20 000                          | 2 contacts in parallel |
| 220 VAC | 10             | Resistive                     | 400 000                         |                        |
| 220 VAC | 3 x 6          | COS Ø = 0.8                   | 200 000                         | 3hp motor              |
| 220 VAC | 5              |                               | 1 500 000                       | Filament lamps         |
| 220 VAC | 5              | Resistive                     | 3 000 000                       |                        |
| 220 VAC | 2.5            | COS Ø = 0.25                  | 2 000 000                       |                        |
| 220 VAC | 2              | Resistive                     | 15 000 000                      |                        |
| 220 VAC | 1.25           | Resistive                     | 30 000 000                      |                        |
| 120 VDC | 1.5            | Resistive                     | 20 000 000                      | with blow-out device   |
| 48 VDC  | 10             | Resistive                     | 1 000 000                       |                        |
| 48 VDC  | 1.5            | 5 ms                          | 18 000 000                      |                        |

### ORDERING INFORMATION

|                           |                  |   |
|---------------------------|------------------|---|
| <b>GP</b>                 | <b>A</b>         | <b>N</b>  |
| Model Series              | Coil Voltage     | Options   |
| GP - Power                | A - 12 VDC       | N - Magnetic Blow-out Device  |
| ML - Magnetic Latch Relay | B - 24 VDC       | Q - Light to indicate coil energization (with 120 VAC, 125 VDC, 220VAC, 250 VDC voltages only) – GP series only   |
|                           | C - 48 VDC       | R - Internal diode to suppress coil de-energization transient (When used on DC unit, relay release time increases to the same value as the AC equivalent.) – GP series only |
|                           | D - 125 VDC      |   |
|                           | F - 250 VDC*     |   |
|                           | G - 24 VAC 60Hz  |   |
|                           | I - 120 VAC 60Hz |   |
|                           | J - 220 VAC 60Hz |   |

Socket Available  
See Page 5

**Control Relays – Series TR Timing Relay**



**DESIGN FEATURES**

- ◆ 4 SPDT Contacts
- ◆ 8 Timing Ranges
- ◆ Magnetic blowout device option increases DC current carrying capacity nearly 10 times for both NO and NC contacts

**DESIGN CONSTRUCTION**

Couples an advanced electromechanical design with a field-proven solid-state timing network, an adaptation of the circuit used in the Agastat premium grade SSC Timer.

This unique circuit also eliminates the need for supplementary temperature-compensation

components, affording unusual stability over a realistically broad operating temperature range. It also provides transient protection and protection against premature switching of the output contacts due to power interruption during timing.

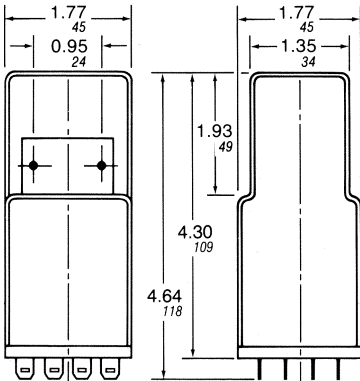

**SPECIFICATIONS**

**Operating Mode:** On-Delay (Delay on energization)

**Timing Adjustment:** Internal Fixed; Internal Potentiometer

**Timing Ranges:**  
 .15 to 3 sec.      4 to 120 sec.  
 .55 to 15 sec.    10 to 300 sec.  
 1 to 30 sec.      1 to 30 min.  
 2 to 60 sec.      2 to 60 min

**Accuracy:** Repeat Accuracy – ±2% at fixed temperature and voltage. Overall Accuracy – ±5% over combined rated extremes of temperature and voltage.

**Reset Time:** 75 msec.

**Coil Operating Voltage:** 24 VDC, 125 VDC ; 120V 50-60 Hz.

**Transient Protection:** 1500 volt transient of less than 100 microseconds, or 1000 Volts or less

**Life:** Load Life

Mechanical life - 100 million operations

**Dielectric:** 2000 VAC between terminals and case and between mutually-isolated contacts.

**Operating Temperature Range:** 32°F to 122°F (0°C to 50°C)

**Mounting/Terminals:** 16 flat base pins. Screw terminal sockets are available.

**Contacts:** Number of contacts – 4 single pole double throw. Nominal rating – 10A @ 120 volts AC. Typical pressure between moving contact and Normally closed contact – 30 grams. Normally open contact – 100 grams

**Insulation Resistance:** Between all non-connected terminals as well as between non-connected terminals and the relay yoke: 1000 megohms at 500 volts DC.

**Approximate Net Weight:** 11 oz.

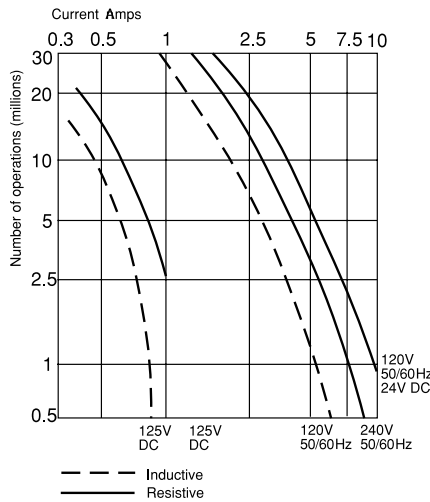
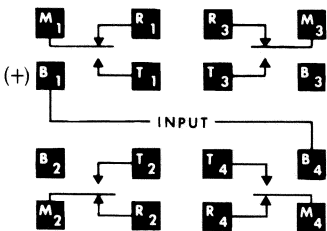

## Control Relays – Series TR Timing Relay

### ORDERING INFORMATION

|  |                           |                     |   |  |  |  |
|--|---------------------------|---------------------|---|--|--|--|
| <b>TR</b>                                | <b>1</b>                  | <b>4</b>            | <b>B</b>  | <b>1</b>   | <b>A</b>   | <b>N</b>                                   |
| Model Series<br>TR - Time Delay<br>Relay | Operation<br>1 - On-Delay | Output<br>4 - 4 PDT | Operating Voltage<br>B - 24 VDC<br>D - 125 VDC<br>I - 120 VAC 50/60Hz | Timing Adjustment<br>1 - Internal Fixed<br>3 - Internal<br>Potentiometer | Timing Range<br>A - .15 to 3 sec.<br>B - .55 to 15 sec.<br>C - 1 to 30 sec.<br>D - 2 to 60 sec.<br>E - 4 to 120 sec.<br>G - 10 to 300 sec.<br>I - 2 to 60 min.<br>N - 1 to 30 min. | Options<br>N - Magnetic<br>Blow-out device |

### FRONT CONNECTED SOCKETS

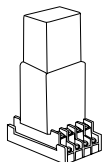

Cat. No. CR0001  
With captive clamp terminals

Cat. No. CR0002  
With (#6) binding head screws

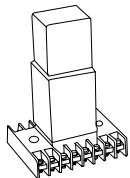
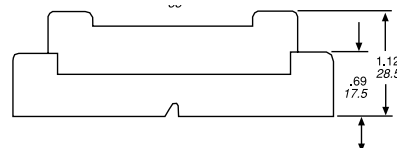
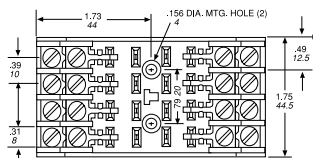

Cat. No. CR0095  
With (#6) screw terminals

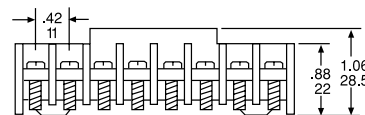
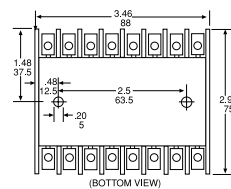

Cat. No. CR0067  
With (#6) screw terminals

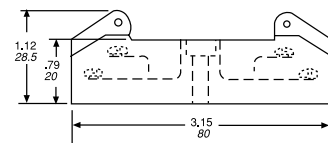
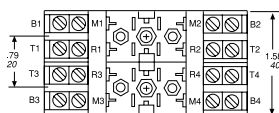

## Accessories

### LOCKING SPRINGS

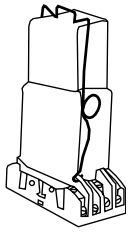

**Cat. No. CR0069**  
For socket: CR0067

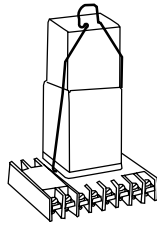
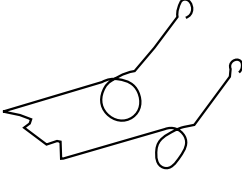

**Cat. No. CR0070**  
For socket: CR0095

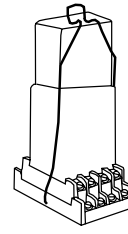
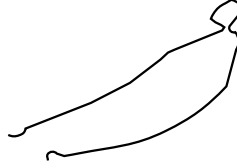

**Cat. No. CR0111**  
For sockets: CR0001 & CR0002



### HEAVY DUTY LOCKING STRAPS

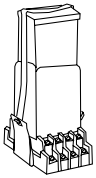

**\*Cat. No. CR0133**  
For socket: CR0001 & CR0002

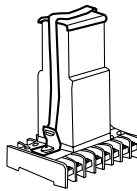

**\*Cat. No. CR0155**  
For socket: CR0095

\* Catalog number includes strap, strap plate and necessary brackets.

### MAGNETIC BLOW OUT DEVICE

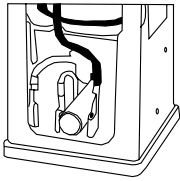

**Cat. No. CR0190**  
Reduces arcing on the relay contacts when they make or break contact, either upon energizing or de-energizing, resulting in less contact degradation. Extends the life of the contact.

### EXTRACTING HANDLE

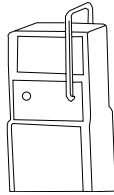

**Cat. No. CR0179**  
Used to remove GP, ML and TR units from mounting bases.