

The Best Relay

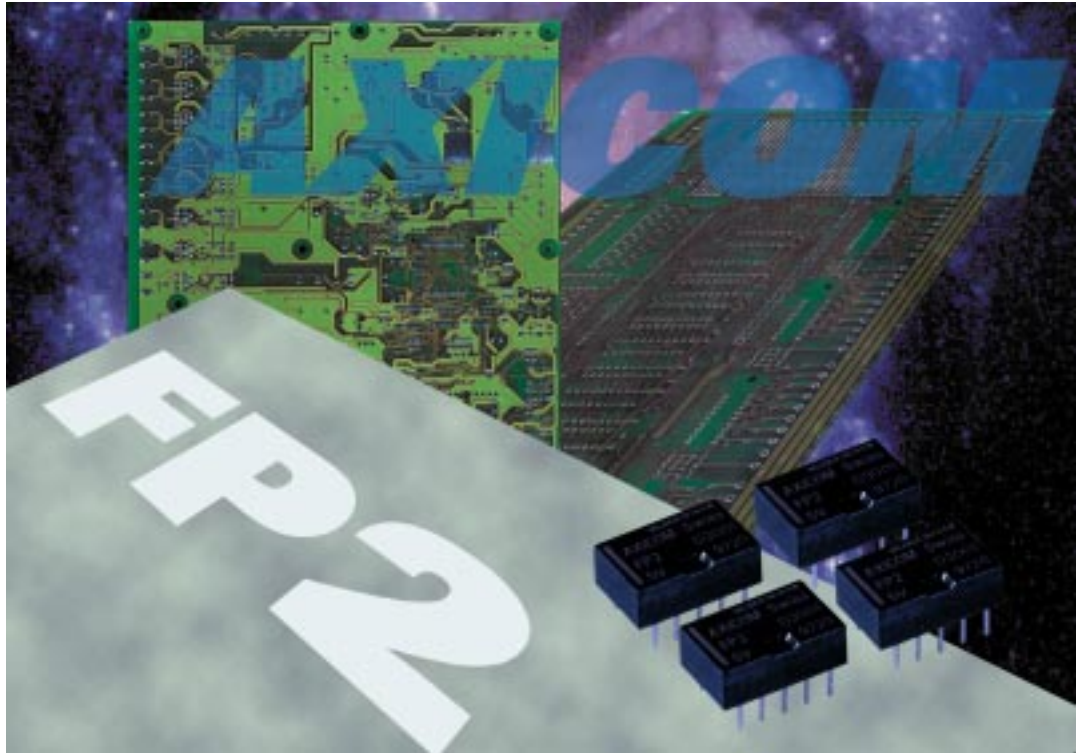

FP2 Relay



2 pole telecom / signal relay
 Through Hole Type (THT)
 Polarized.

Relay types: non-latching with 1 coil
 latching with 1 coil
 latching with 2 coils

Features

- Telecom / signal relay (dry circuit, test access, ringing)
- Slim line 14 x 9 mm, 0.550 x 0.354 inch
- Switching current 1,25 A
- 2 changeover contacts (2 form C / DPDT)
- Bifurcated contacts
- High sensitivity results in low nominal power consumption
 80 mW for high sensitive, 140 mW for sensitive version
- High mechanical shock resistance
 up to 300 g functional
 up to 1500 g survival

Typical applications

- Communications equipment
 Linecard application - analog, ISDN, xDSL, PABX
 Voice over IP
- Office and business equipment
- Measurement and control equipment
- Consumer electronics
 Set top boxes, HiFi
- Medical equipment

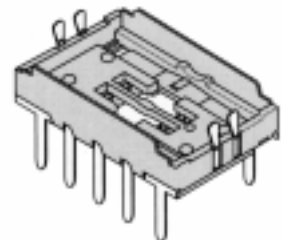
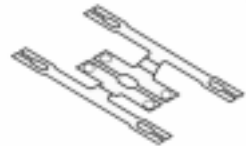
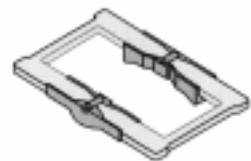
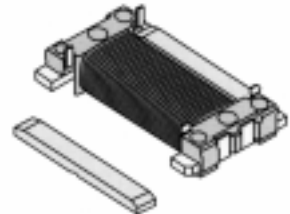

CSA-C22.2 No 14-95 File No. 176679-1079886



UL 508 File No. E111441



CECC 16503-001



QC 160503-CH0001

Dimensions

THT		
	mm	inch
L	14.02 ± 0.08	0.574 ± 0.008
W	9.02 ± 0.08	0.035 ± 0.003
H	5 ± 0.1	0.196 ± 0.004
T	3.2 ± 0.3	0.125 ± 0.011
T1	N/A	N/A
T2	7.62 ± 0.1	0.3 ± 0.004
Tw	0.5	0.020
S	0.25 ± 0.05	0.009 ± 0.002

THT Version

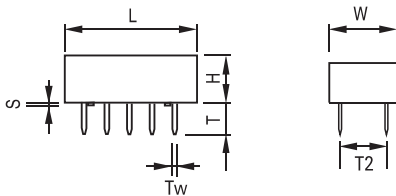

Mounting hole layout

View onto the component side of the PCB
(top view)

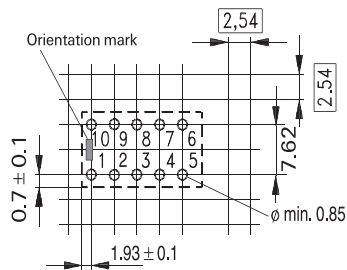

Basic grid 2.54 mm

Terminal assignment

Relay - top view

Non-latching type,
not energized condition

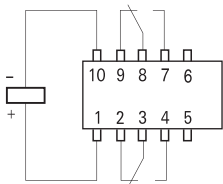

Latching type,
reset condition

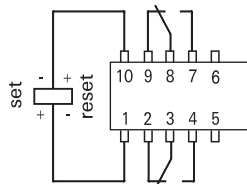

latching, 2 coils
reset condition

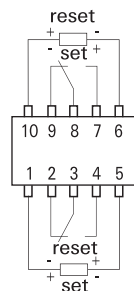

Coil Data (values at 23°C)

Nominal voltage U_{nom}	Operate/set voltage range		Release/ reset voltage Minimum	Nominal power consumption	Resistance	Relay Code
	Minimum voltage U_I	Maximum voltage U_{II}				
Vdc	Vdc	Vdc	Vdc	mW	$\Omega / \pm 10\%$	

non-latching
1 coil

3	2.1	6.8	0.30	140	64	D 3006
4.5	3.15	10.3	0.45	140	145	D 3004
5	3.5	11.4	0.50	140	178	D 3009
6	4.2	13.7	0.60	140	257	D 3005
9	6.3	20.4	0.90	140	574	D 3010
12	8.4	27.3	1.20	140	1028	D 3002
24	16.8	45.7	2.40	200	2880	D 3012
48	33.6	67.5	4.80	300	7680	D 3013

non-latching 1 coil
high sensitive version

3	2.25	9.0	0.3	80	113	D 3021
4.5	3.38	13.5	0.45	80	253	D 3022
5	3.75	15.0	0.5	80	313	D 3023
6	4.5	18.0	0.6	80	450	D 3024
9	6.75	27.1	0.9	80	1013	D 3025
12	9.00	36.1	1.2	80	1800	D 3026
24	18.00	54.7	2.4	140	4114	D 3027
48	36.00	72.5	4.8	260	8882	D 3028

latching
1 coil

3	2.25	8.1	2.25	100	90	D 3041
4.5	3.375	12.1	3.375	100	203	D 3042
5	3.75	13.5	3.75	100	250	D 3043
6	4.5	16.2	4.50	100	360	D 3044
9	6.75	24.2	6.75	100	810	D 3045
12	9.00	29.0	9.00	100	1440	D 3046
24	18.00	47.5	18.00	150	3840	D 3047

latching
2 coils

3	2.1	5.7	2.1	200	45	D 3061
4.5	3.15	8.6	3.15	200	101	D 3062
5	3.5	9.5	3.5	200	125	D 3063
6	4.2	11.4	4.2	200	180	D 3064
9	6.3	17.1	6.3	200	405	D 3065
12	8.4	22.6	8.4	200	720	D 3066
24	16.8	33.7	16.8	200	1920	D 3067

Further coil versions are available on request.

U_I = Minimum voltage at 23° C after pre-energizing with nominal voltage without contact current
 U_{II} = Maximum continuous voltage at 23°

The operating voltage limits U_I and U_{II} depend on the temperature according to the formula:

$U_{I \text{ tamb}} = K_I \cdot U_{I \text{ 23}^\circ \text{ C}}$
 and
 $U_{II \text{ tamb}} = K_{II} \cdot U_{II \text{ 23}^\circ \text{ C}}$
 t_{amb} = Ambient temperature
 $U_{I \text{ tamb}}$ = Minimum voltage at ambient temperature, t_{amb}
 $U_{II \text{ tamb}}$ = Maximum voltage at ambient temperature, t_{amb}
 K_I, K_{II} = Factors (dependent on temperature), see diagram

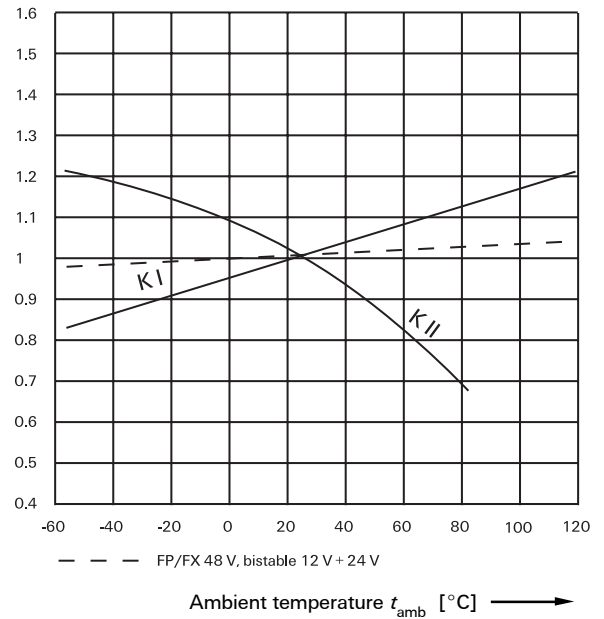

Contact Data		
Number of contacts and type	2 changeover contacts	
Contact assembly	Bifurcated contacts	
Contact material	Silver-nickel, gold-covered	
Limiting continuous current at max. ambient temperature	2 A	
Maximum switching current	2 A	
Maximum switching voltage	125 Vdc 250 Vac	
Maximum switching capacity	30 W, 62.5 VA	
Thermoelectric potential	< 10 μ V	
Initial contact resistance / measuring condition: 10 mA / 20 mV	< 70 m Ω	
Electrical endurance	at contact application 0 (≥ 30 mV / ≥ 10 mA) at cable load open end at 125 Vdc / 0.24 A - 30 W at 250 Vac / 0.25 A - 62.5 VA at 24 V / 1.25 A - 30 W	min. 2.5×10^6 operations min. 2.0×10^6 operations min. 1.0×10^5 operations min. 1.0×10^5 operations min. 3.0×10^5 operations
Mechanical endurance	typ. 10^8 operations	
UL/CSA ratings	30 Vdc / 1.25 A 50 Vdc / 0.5 A 50 Vac / 0.5 A	

Insulation		
Insulation resistance at 500 VDC	> $10^9 \Omega$	
Dielectric test voltage (1 min)	between coil and contacts between adjacent contact sets between open contacts	1000 Vrms 1000 Vrms 750 Vrms
Surge voltage resistance	according IEC (10 / 700 μ s) between coil and contacts between adjacent contact sets between open contacts according to FCC 68 (10 / 160 μ s) between coil and contacts between adjacent contact sets between open contacts	1500 V 1500 V 1500 V 1500 V 1500 V 1500 V 1500 V

High Frequency Data	
Capacitance	
between coil and contacts	max. 4 pF
between adjacent contact sets	max. 1 pF
between open contacts	max. 1 pF
RF Characteristics	
Isolation at 100 / 900 MHz	-40.2 dB / -22.3 dB
Insertion loss at 100 / 900 MHz	-0.03 dB / -0.25 dB
V.S.W.R. at 100 / 900 MHz	1.01 / 1.07

General data	
Operate time at U_{nom} typ. / max.	3 ms / 4 ms
Reset time (latching) at U_{nom} , typ. / max.	3 ms / 4 ms
Release time without diode in parallel (non-latching), typ. / max.	1 ms / 3 ms
Release time with diode in parallel (non-latching), typ. / max.	3 ms / 4 ms
Bounce time at closing contact, typ. / max.	1 ms / 5 ms
Maximum switching rate without load	50 operations/s
Ambient temperature	-55° C ... +85° C
Thermal resistance	< 165 K/W
Maximum permissible coil temperature	110° C
Vibration resistance (function)	20 g 10 to 500 Hz
Shock resistance, half sinus, 11 ms	50 g (function) 1500 g (damage)
Degree of protection	immersion cleanable, IP 67
Needle flame test	application time 20 s, no burning or glowing
Mounting position	any
Processing information	Ultrasonic cleaning is not recommended
Weight (mass)	max. 2 g
Resistance to soldering heat	260° C / 10 s

All data refers to 23° C unless otherwise specified.

Packing

Tube for THT version - 50 relays per stick, 1000 relays per box

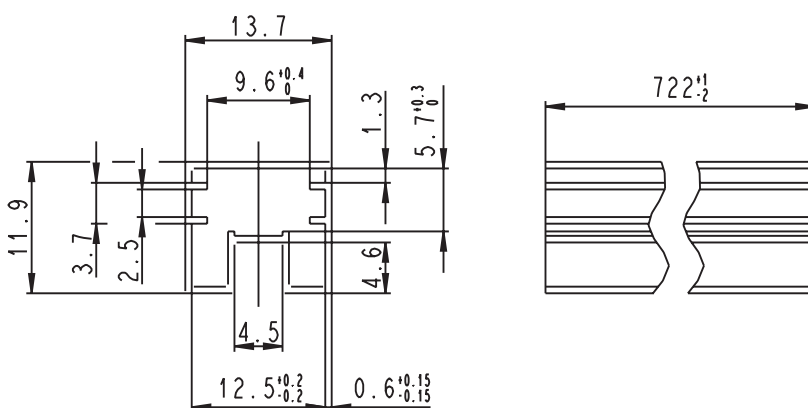

Ordering Information

Relay Code	Tyco Part Number	Relay Code	Tyco Part Number
D3002	0-1462033-5	D3041	4-1462033-0
D3004	0-1462033-9	D3042	4-1462033-1
D3005	1-1462033-1	D3043	4-1462033-2
D3006	1-1462033-3	D3044	4-1462033-3
D3009	1-1462033-4	D3045	4-1462033-4
		D3046	4-1462033-5
		D3047	4-1462033-6
D3010	2-1462033-1	D3061	4-1462033-7
D3012	2-1462033-2	D3062	4-1462033-8
D3013	2-1462033-6	D3063	4-1462033-9
D3021	3-1462033-2	D3064	5-1462033-0
D3022	3-1462033-3	D3065	5-1462033-1
D3023	3-1462033-4	D3066	5-1462033-4
D3024	3-1462033-5	D3067	5-1462033-6
D3025	3-1462033-6		
D3026	3-1462033-7		
D3027	3-1462033-8		
D3028	3-1462033-9		

IM Relays

4th generation slim line – low profile polarized 2 c/o telecom relay with bifurcated contacts, available as non latching or latching relay with 1 coil. Nominal voltage range from 1.5... 24 V, coil power consumption of 140... 200 mW, latching relays with 1 coil 100 mW. The IM relay is available as through hole and surface mount type (J-Legs and Gull Wings) and capable to switch loads up to 60 W/62,5 VA. Dielectric strength fulfills the Bellcore requirements according GR 1089 (2,5 kV – 2 / 10 μ s) and FCC part 68 (1,5 kV – 10 / 160 μ s). The IM is CECC/IECQ approved and certified in accordance with IEC/EN 60950 and UL1950. Dimensions approx. 10 x 6 mm board space and 5,65 mm height.

P2 Relays

3rd generation polarized 2 c/o telecom relay with bifurcated contacts, available as non latching or latching relay with 1 or 2 coils. Nominal voltage range from 3 ... 24 V, coil power consumption 140 mW, latching relays with 1 coil 70 mW. The P2 relay is available as through hole or surface mount type and capable to switch currents up to 5 A. Dielectric strength fulfills the Bellcore requirements according GR 1089 (2,5 kV – 2 / 10 μ s) and FCC part 68 (1,5 kV – 10 / 160 μ s). Dimensions approx. 15 x 7,5 mm board space and 10 mm height.

FX Relays

3rd generation polarized 2 c/o telecom relay with bifurcated contacts, available as non latching or latching relay with 1 coil. Nominal voltage range from 3 ... 48 V, coil power consumption of 80 ... 260 mW for the high sensitive version, 140... 300 mW for the standard version, latching relays with 1 coil 100 mW. The FX2 relay is available as through hole type and capable to switch loads up to 60 W/62,5 VA. Dielectric strength fulfills the Bellcore requirements according GR 1089 (2,5 kV – 2 / 10 μ s) and FCC part 68 (1,5 kV – 10 / 160 μ s). The FX2 is CECC/IECQ approved and certified in accordance with IEC/EN 60950 and UL1950. Dimensions approx. 15 x 7,5 mm board space and 10,7 mm height.

FT2 / FU2 Relays

3rd generation non polarized, non latching 2 c/o telecom relay with bifurcated contacts. Nominal voltage range from 3 ... 48 V, coil power consumption 200 ... 300 mW. Most sensitive 48 V relay. Available as through hole and surface mount type. Dielectric strength fulfills the Bellcore requirements according GR 1089 (2,5 kV – 2 / 10 μ s) and FCC part 68 (1,5 kV – 10 / 160 μ s). The FT2/FU2 is CECC/IECQ approved and certified in accordance with IEC/EN 60950 and UL1950. Dimensions approx. 15 x 7,5 mm board space and 10 mm height.

FP2 Relays

3rd generation polarized 2 c/o telecom relay with bifurcated contacts, available as non latching or latching relay with 1 or 2 coils. Nominal voltage range from 3 ... 48 V, coil power consumption of 80 ... 260 mW for the high sensitive version, 140... 300 mW for the standard version, latching relays with 1 coil 100 mW. The FP2 relay is available as through hole type and capable to switch loads up to 30 W/62,5 VA. Dielectric strength fulfills FCC part 68 (1,5 kV – 10 / 160 μ s). The FP2 is CECC/IECQ approved. Dimensions approx. 14 x 9 mm board space and 5 mm height.

MT2 / MT4

2nd generation non polarized, non latching 2 c/o and 4 c/o telecom and signal relay with bifurcated contacts. Nominal voltage range from 4.5 ... 48 V, coil power consumption 150/200/300/400 and 550 mW, and 300 mW (MT4). Dielectric strength fulfills the

requirements according FCC part 68 (1,5 kV – 10 / 160 μ s) for both and the Bellcore requirements according GR 1089 (2,5 kV – 2 / 10 μ s) the MT4 only.

Dimensions MT2 approx. 20 x 10 mm board space and 11 mm height, MT4 approx. 20 x 15 mm board space and 11 mm height.

D2n Relays

2nd generation non polarized 2 c/o relay for telecom and various other applications. Nominal voltage range from 3 ... 48 V, coil power consumption from 150 ... 500 mW. The D2n relay is capable to switch currents up to 3 A. Dielectric strength fulfills the requirements according FCC part 68 (1,5 kV – 10 / 160 μ s). Dimensions approx. 20 x 10 mm board space and 11,5 mm height.

P1 Relays

Extremely sensitive, polarized 1 c/o relay with bifurcated contacts for a wide range of applications, available as non latching or latching relay with 1 or 2 coils. Nominal voltage range from 3 ... 24 V, coil power consumption 65 mW, latching relays with 1 coil 30 mW. The P1 relay is available as through hole or surface mount type and capable to switch currents up to 1 A. Dielectric strength fulfills the requirements according FCC part 68 (1,5 kV – 10 / 160 μ s). Dimensions approx. 13 x 7,6 mm board space and 7 mm height for THT or 8 mm height for SMT version.

W11 Relays

Low cost, non polarized 1 c/o relay for various applications. Nominal voltage range from 3 ... 24 V, coil power consumption 450 mW, sensitive versions 200 mW. The W11 relay is capable to switch currents up to 3 A. Dielectric strength 1000 Vrms. Dimensions approx. 15,6 x 10,6 mm board space and 11,5 mm height.

Reed Relays

High sensitive, non polarized relay for telecom and various other applications, available with 1 n/o, 2 n/o or 1c/o contacts. Nominal voltage range from 5 ... 24 V, coil power consumption 50...280 mW for 1 n/o and 125 ... 280 mW for 2 n/o or 1 c/o versions. Reedrelays are available in DIP or SIL housing and capable to switch currents up to 0,5 A. Integrated diode and/or electrostatic shield optional. Dielectric strength 1500 Vdc. Dimensions approx. 19,3 x 7 mm board space and 5 ... 7,5 mm height for DIP or 19,8 x 5 mm board space and 7,8 mm height for SIL version.

Cradle Relays

Extremely reliable and mature relay family of 1st generation for various signal switching applications. Available as non polarized, polarized / latching and relay with AC coil. The benefit is the possibility of combining various contact sets from 1 up to 6 poles, single and bifurcated contacts, different contact materials with a coil voltage range from 1,5 Vdc to 220 Vac. Cradle relays are available as dust protected and hermetically sealed versions, with plug in or solder terminals and are capable to switch currents up to 5 A. Forcibly guided (linked) contact sets optional. Dielectric strength 500 Vrms. Dimensions from approx. 19 x 24 to 19x35 mm board space and 30 mm height.

Other Relays

We offer a variety of different relay families for maintenance and replacement purposes. These relays are up to 60 years old now, such as Card Relay SN (V23030 / V23031 series), Small General Purpose Relay (V23006 series), Small Polarized Relay (V23063 ... V23067 and V23163 ... V23167 series). Accessories like sockets, hold down springs, etc. optional.



Tyco Electronics AXICOM Ltd.
Seestrasse 295 - P.O. Box 220
CH-8804 Au-Wädenswil / Switzerland
Phone +41 1 782 9111
Fax +41 1 782 9080
E-mail: axicom@tycoelectronics.com



Tyco Electronics AMP GmbH
Paulsternstrasse 26
D-13629 Berlin / Germany
Phone +49 30 386 38260
Fax +49 30 386 38569
E-mail: axicom@tycoelectronics.com



Tyco Electronics EC Trutnov s.r.o.
Komenského 821
CZ-541 01 Trutnov / Czech Republic
E-mail: axicom@tycoelectronics.com

Tyco Electronics Corporation
POB 3608,
Harrisburg, PA 17105, USA
Phone +1 800-522-6752